

Panasonic

Quick Reference Guide

IP Proprietary Telephone
Model No. **KX-NT551/KX-NT553**
KX-NT556

Thank you for purchasing this Panasonic product. Please read this manual carefully before using this product and save this manual for future use. For more details, please refer to the manuals of the PBX.

This product supports the following PBX versions and CODEC types:

- KX-NS300/KX-NS500: PFMPR Software File Version 1.0000 or later
- KX-NS1000: PCMPR Software File Version 3.0000 or later
- KX-NCP500/KX-NCP1000: PBMPR Software File Version 8.0000 or later
- KX-TDE100/KX-TDE200: PMMPR Software File Version 8.0000 or later
- KX-TDE600: PGMPR Software File Version 8.0000 or later
- CODEC: G.722, G.711, G.729A

Note

- In this manual, the suffix of each model number is omitted unless necessary.
- The illustrations may differ from the appearance of the actual product.

Trademarks

- Plantronics is a trademark or registered trademark of Plantronics, Inc.
- All other trademarks identified herein are the property of their respective owners.

Important Information

Information for Users on Collection and Disposal of Old Equipment and used Batteries

These symbols on the products, packaging, and/or accompanying documents mean that used electrical and electronic products and batteries should not be mixed with general household waste.

For proper treatment, recovery and recycling of old products and used batteries, please take them to applicable collection points, in accordance with your national legislation and the Directives 2002/96/EC and 2006/66/EC.

By disposing of these products and batteries correctly, you will help to save valuable resources and prevent any potential negative effects on human health and the environment which could otherwise arise from inappropriate waste handling.

For more information about collection and recycling of old products and batteries, please contact your local municipality, your waste disposal service or the point of sale where you purchased the items.

Penalties may be applicable for incorrect disposal of this waste, in accordance with national legislation.



For business users in the European Union

If you wish to discard electrical and electronic equipment, please contact your dealer or supplier for further information.



Information on disposal in other countries outside the European Union

These symbols are only valid in the European Union. If you wish to discard these items, please contact your local authorities or dealer and ask for the correct method of disposal.



Note for the battery symbol (bottom two symbol examples):

This symbol might be used in combination with a chemical symbol. In this case it complies with the requirement set by the Directive for the chemical involved.

For Users in the European Union

**For information of Compliance with EU relevant Regulatory Directives,
Contact to Authorized Representative:**

Panasonic Testing Center



Panasonic Marketing Europe GmbH

Winsbergring 15, 22525 Hamburg, Germany

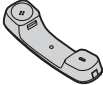

Accessory Information

Included Accessories

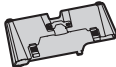
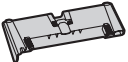



Handset (1)	Handset Cord (1)	Stand (1)	
		KX-NT551 	KX-NT553/ KX-NT556 

Optional Accessories

	KX-NT551	KX-NT553	KX-NT556
AC adaptor*1	KX-A239CE (PQLV206CE)		
Wall mount kit	KX-A432X	KX-A433X	
Add-on 48 key module	—	KX-NT505X*2	

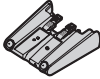
*1 To order an optional AC adaptor, please order using the "KX-A239xx" model number (not "PQLV206xx"). Can also be used with the KX-NT505X.

*2 KX-NT505X has the following accessories.

Stand (1)	Wall mounting adaptor (1)	Screws for wall mounting (3)*1	Screws for attaching to the unit (2)
			

*1 Two screws for attaching the KX-NT505X to a wall.
One screw for attaching the wall mounting adaptor to the unit.

Location of Controls

KX-NT551

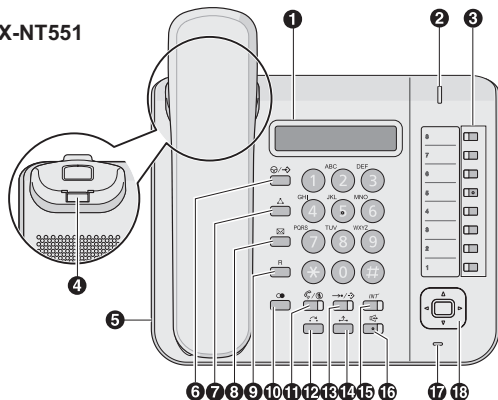

KX-NT553
KX-NT556

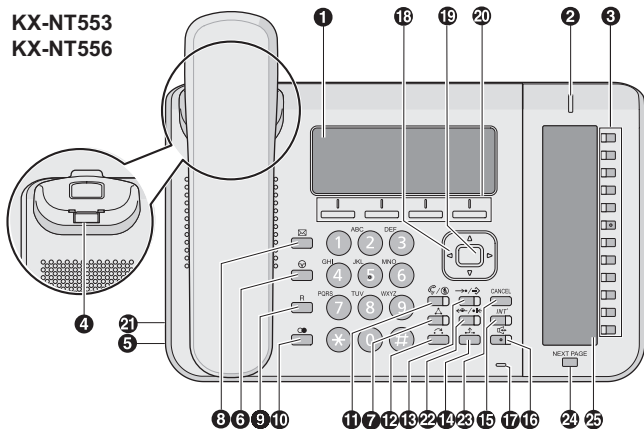

Location of Controls

- 1 **Main LCD (Liquid Crystal Display):**
KX-NT551: 1 line, KX-NT553: 3 lines, KX-NT556: 6 lines
- 2 **Message/Ringer Lamp:**
When you receive an intercom call, the lamp flashes green, and on an outside call, the lamp flashes red. When someone has left you a message, the lamp stays on red.
- 3 **Flexible CO Buttons:** Used to seize an outside line or perform a feature that has been assigned to the key.
- 4 **Handset Hook:** Keeps the handset stable when the unit is mounted on a wall.
- 5 **Headset Jack**
- 6 **Ⓜ/→ (PAUSE/PROGRAM)** (For KX-NT551): Used to insert a pause when storing a telephone number. This button is also used for programming this unit.
Ⓜ (PAUSE) (For KX-NT553/KX-NT556): Used to insert a pause when storing a telephone number.
- 7 **△ (CONF):** Used to establish a multiple party conversation.
- 8 **✉ (MESSAGE):** Used to leave a message waiting indication or call back the party who left the message waiting indication.
- 9 **R (FLASH/RECALL):** Used to disconnect the current call and make another call without hanging up.
- 10 **● (REDIAL):** Used to redial the last dialed number.
- 11 **📞 / 📞 (AUTO ANS/MUTE):** Used to receive an incoming call in hands-free mode or mute the microphone/handset during a conversation.
- 12 **↪ (TRANSFER):** Used to transfer a call to another party.
- 13 **→ / ↗ (AUTO DIAL/STORE):** Used for System/Personal Speed Dialing or storing programme changes.
- 14 **⏸ (HOLD):** Used to place a call on hold.
- 15 **INT' (INTERCOM):** Used to make or receive intercom calls.
- 16 **📢 (SP-PHONE [Speakerphone]):** Used for performing hands-free operations.

- 17 **Microphone:** Used for hands free conversations.
- 18 **Navigator Key:** Used to adjust the volume and the display contrast or select desired items.
- 19 **ENTER*1:** Used to assign the selected item.
- 20 **Soft Buttons (S1-S4)*1:** S1-S4 (located from left to right) are used to select the item displayed on the bottom line of the display.
- 21 **EHS (Electronics Hook Switch) Jack*1**
- 22 **FWD/DND*1:** Used to switch Call Forwarding or Do Not Disturb on your extension.
- 23 **CANCEL*1:** Used to cancel the selected item.
- 24 **NEXT PAGE*1:** Used to switch the page for the Self Labeling feature.
- 25 **Sub LCD*1:** 12 lines

*1 KX-NT553/KX-NT556 only

Before Operating the Telephone

Speaker volume

While in a hands-free conversation
Press [▲] or [▼] to adjust the volume.

Handset/Headset volume*1

While using the handset or headset
Press [▲] or [▼] to adjust the volume.

Ringer volume

While on-hook or receiving a call
Press [▲] or [▼] to adjust the volume.

LCD Contrast (For main LCD)*2

While on-hook

1. Press the **PROG** soft button (S1).*3
2. Enter 01.
3. Press [ENTER].*4
4. Press [▲] or [▼] to adjust the LCD contrast.
5. Press [ENTER].*4
6. Press [CANCEL].*3

*1 If you hear your own voice through the handset or headset, decrease the volume.

*2 To change the sub LCD contrast of the KX-NT553/KX-NT556, enter 05 in Step 2.

*3 For KX-NT551, press  [PAUSE/PROGRAM].

*4 For KX-NT551, press  [AUTO DIAL/STORE].

Ring Tone

1. Press the **PROG** soft button (S1).^{*1}
2. Press a flexible CO button or *INT'* [INTERCOM] 2 times.
3. Enter 2 digits (01-30) using the dial keys (0-9), or press [▲] or [▼] to select the ring tone.
4. Press [ENTER].^{*2}
5. Press [CANCEL].^{*1}

LCD Backlight

While on-hook

1. Press the **PROG** soft button (S1).^{*1}
2. Enter ④④.
3. Press [ENTER].^{*2}
4. Press a dial key to select the LCD backlight mode.
④: Automatic
①: Always ON
②: Always OFF
5. Press [ENTER].^{*2}
6. Press [CANCEL].^{*1}

^{*1} For KX-NT551, press /[PAUSE/PROGRAM].

^{*2} For KX-NT551, press /[AUTO DIAL/STORE].

Feature Operations

Making Calls

Calling

[To an extension]

1. Go off-hook.
2. Dial an extension number.

[To an outside party]

1. Go off-hook.
2. Press a flexible CO button.
3. Dial the outside party's phone number.

Redial

1. Go off-hook.
2. Press **●**[REDIAL].

Quick Dialing

1. Go off-hook.
2. Dial a quick dialing number.

Doorphone Call

1. Go off-hook.
2. Enter **(*)3(1)**.
3. Enter a doorphone number (2 digits).
4. After the confirmation tone, talk.

System Speed Dialing

1. Go off-hook.
2. Press **→•/•↔**[AUTO DIAL/STORE].
3. Enter a system speed dialing number (3 digits).

Personal Speed Dialing

【To store】

1. Go off-hook.
2. Enter $\text{Ⓢ} \text{③} \text{①}$.
3. Enter a personal speed dialing number (2 digits).
4. Enter the phone number to store (max. 32 digits).^{*1}
5. Press Ⓢ .
6. After the confirmation tone, go on-hook.

【To dial】

1. Go off-hook.
2. Press $\text{→} \text{•} / \text{→} \text{↗}$ [AUTO DIAL/STORE].
3. Enter Ⓢ .
4. Enter a personal speed dialing number (2 digits).

One-touch Dialing

【To store】

1. Press the **PROG** soft button (S1).^{*2}
2. Press a flexible CO button.
3. Enter ② .
4. Enter the number to store (max. 32 digits).^{*1}
5. Press [ENTER].^{*3}
6. Enter the text to store (max. 12 digits).^{*4}
7. Press [ENTER].^{*4}
8. Press [CANCEL].^{*2}

【To dial】

1. Go off-hook.
2. Press the flexible CO button assigned as a One-touch Dialing button.

^{*1} Enter the outside line access number before an outside phone number.

^{*2} For KX-NT551, press $\text{Ⓢ} / \text{→} \text{↗}$ [PAUSE/PROGRAM].

^{*3} For KX-NT551, press $\text{→} \text{•} / \text{→} \text{↗}$ [AUTO DIAL/STORE].

^{*4} KX-NT553/KX-NT556 only

During a Conversation

Call Hold

[To hold]

1. Press [HOLD].
2. After the confirmation tone, go on-hook.

[To retrieve a call at the holding extension]

1. Go off-hook.
2. Press a flexible CO button or *INT'* [INTERCOM].

[To retrieve an outside call from another extension]

1. Go off-hook.
2. Press a flexible CO button.

Call Transfer

[To an extension]

1. Press [TRANSFER].
2. After the confirmation tone, dial an extension number.
3. Talk.
4. Go on-hook.

[To an outside party]

1. Press [TRANSFER].
2. After the confirmation tone, press a flexible CO button.
3. Dial an outside phone number.
4. Talk.
5. Go on-hook.

Setting the Telephone According to Your Needs

Do Not Disturb

1. Go off-hook.
2. Enter *71.
3. Press a dial key to select the setting.
0: Both outside and intercom calls
1: Outside calls only
2: Intercom calls only
4. To enable Do Not Disturb, enter 1.
To cancel Do Not Disturb, enter 0.
5. After the confirmation tone, go on-hook.

Timed Reminder

[To set]

1. Go off-hook.
2. Enter *7601.
3. Enter the hour and minute (4 digits).
4. If 12-hour-time display is set, enter 0 (AM) or 1 (PM).
5. Enter 0 (1 time) or 1 (daily).
6. After the confirmation tone, go on-hook.

[To cancel]

1. Go off-hook.
2. Enter *7600.
3. After the confirmation tone, go on-hook.

[To stop or answer the ring back]

1. Press *INT'* [INTERCOM], or go off-hook.

Useful Features

Multiple Party Conversation

[To add other parties during a conversation]

1. Press Δ [CONF].
2. After the confirmation tone, dial the phone number of the party to add.
3. Talk to the new party.
4. Press Δ [CONF].
5. After the confirmation tone, talk with multiple parties.

[To leave a conference]

1. Press Δ [CONF].
2. After the confirmation tone, go on-hook.

Before Leaving Your Desk

Call Forwarding

1. Go off-hook.
2. Enter $(*)7(1)$.
3. Press a dial key to select the types of calls to apply this feature to.
 - ①: Both outside and intercom calls
 - ②: Outside calls only
 - ③: Intercom calls only
4. Press a dial key to select the status.
 - ②: All calls
 - ③: Busy
 - ④: No answer
 - ⑤: Busy/No answer
 - ⑥: Cancel*1
5. Enter an extension number, and then enter $(\#)$, or enter a CO line access number, an outside phone number, and then enter $(\#)$.
6. After the confirmation tone, go on-hook.

*1 If you enter ⑥ in Step 4, you can skip Step 5.

Self Labeling (KX-NT553/KX-NT556 only)

The KX-NT553/KX-NT556 features 12 flexible buttons, with an LCD screen next to the buttons. Each item can be named on the LCD screen through personal or system programming to reflect the function of its corresponding flexible button. Additionally, the KX-NT553 (KX-NT556) flexible buttons can be organized into 2 (3) "pages", allowing you to assign a total of 24 (36) items to the 12 flexible buttons. You can toggle between pages by pressing [NEXT PAGE], as follows:

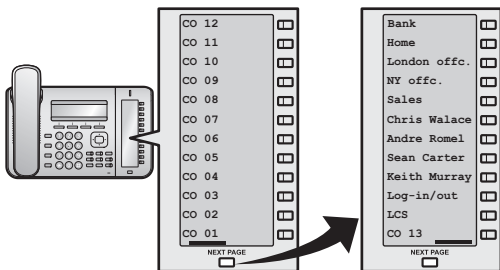

Storing a One-touch Dialing button, and setting the displayed text for the Self Labeling LCD

1. Press the **PROG** soft button (S1).
2. Press a flexible CO button, or press [NEXT PAGE], and then press a flexible CO button.
3. Enter ②.
4. Enter the number to store (max. 32 digits).^{*1}
5. Press [ENTER].
6. Enter the text to store (max. 12 digits).
7. Press [ENTER].
8. Press [CANCEL].

^{*1} Enter the outside line access number before an outside phone number.

Installation and Setup

Note

- Panasonic assumes no responsibility for injuries or property damage resulting from failures arising out of improper installation or operation inconsistent with this documentation.

Attaching a KX-NT505 to the KX-NT553/KX-NT556

The KX-NT505 allows 48 additional flexible CO buttons to be added to this unit. These buttons are used to seize an outside line, make a call using One-touch Dialing, or perform a feature that has been assigned to the key.



1. Open the flat cable cover of your unit.

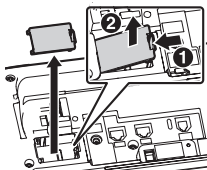

2. Attach the KX-NT505 to your unit with the 2 screws*1.

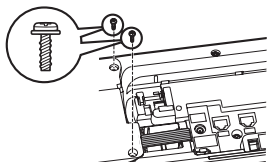

3. Plug the flat cable into the connector (1), then bend the cable slightly as shown (2).

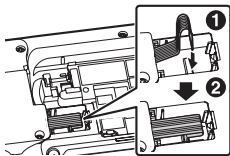

4. Close the cover.

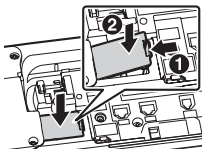

*1 Included with the KX-NT505X.

CAUTION

- Before you install or uninstall the Add-on 48 key module, turn off the unit by disconnecting the AC adaptor (if connected) and the Ethernet cable connected to the switching hub.

Note

- Up to 4 Add-on 48 key modules can be connected. If 2 or more key modules are connected, an AC adaptor must be connected to the second key module. If only 1 key module is connected, an AC adaptor is not required.
- Use only the Panasonic AC adaptor. See “Optional Accessories”, Page 4.

Attaching the Stand

KX-NT551

- 1 Insert the catches of the stand into the hooks located in the unit.
- 2 Gently push the stand in the direction indicated until it locks into place. The stand will be mounted.

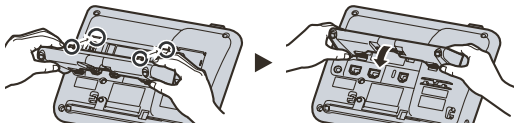

KX-NT553/KX-NT556/KX-NT505

- 1 Insert the catches (A) of the stand into hooks located in the unit.
- 2 Gently push the stand in the direction indicated until it locks into place. The stand will be mounted in the high position.

Example: KX-NT556

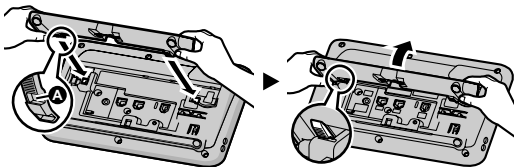

Removing the Stand

KX-NT551

- 1 Remove the stand in the direction indicated while pushing the catches of the stand with both hands as shown.

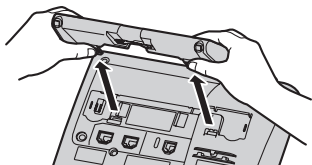

KX-NT553/KX-NT556/KX-NT505

- 1 Hold the stand with both hands.
- 2 Gently rotate the stand in the direction indicated until it is released.

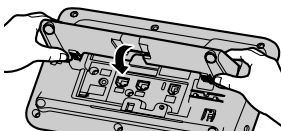

Example: KX-NT556

Connections

KX-NT551

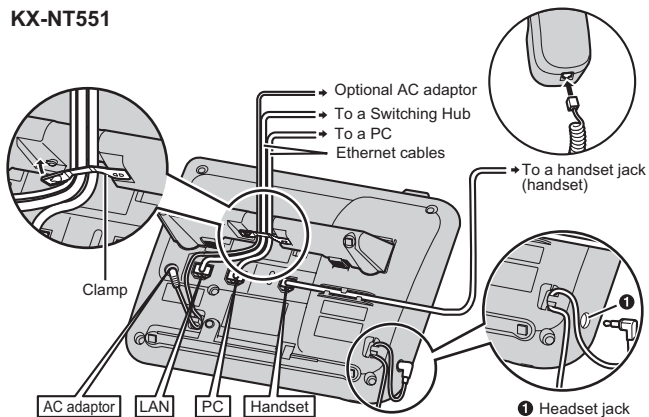

KX-NT553/KX-NT556

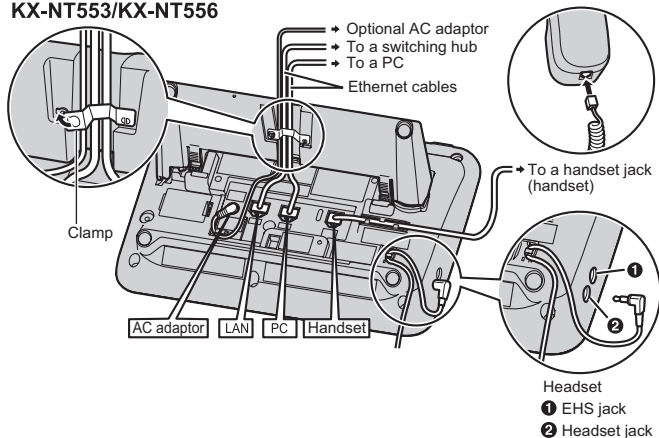

Installation and Setup

Note

- When connecting a headset, the following headsets can be used with this unit. (Not all operations with the headsets can be guaranteed.)
 - Wired headsets
Panasonic RP-TCA400 or RP-TCA430
 - EHS headsets (KX-NT553/KX-NT556 only)
Selected Plantronics®-brand headsets
- For up-to-date information about headsets that have been tested with this unit, refer to the following web sites:
<http://panasonic.net/pcc/support/pbx/>

When selecting Ethernet cables (not included)

- Use flexible cables without jack covers. Do not use cables with a hard coating that may tear or crack when bent.
To prevent damage to the cables, use cables that do not protrude from the bottom of the base.
Connect the cables as shown in the following illustration.

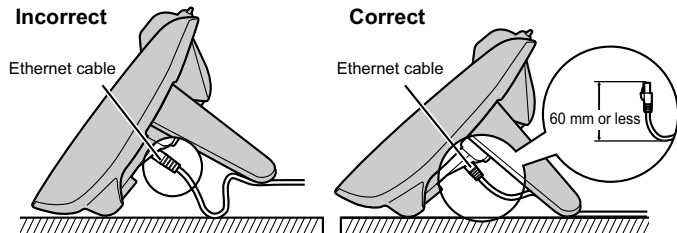

- Use a straight CAT 5e (or higher) Ethernet cable (not included) that is 6.5 mm in diameter or less.

When connecting to a switching hub

- If PoE is available, an AC adaptor is not needed.
- KX-NT551/KX-NT553/KX-NT556 comply with the PoE Class 3 standard.

When connecting a PC

- The PC port does not support PoE for connected devices.

When connecting cables and the AC adaptor

- Ensure that the Ethernet cables and the AC adaptor cord are clamped to prevent damage to the connectors.

Wall Mounting

Note

- When mounting the KX-NT553/KX-NT556 with a KX-NT505 on the wall, attach the KX-NT505 to the KX-NT553/KX-NT556 first, and then mount them on the wall. For detail about the attaching, see “Attaching a KX-NT505 to the KX-NT553/KX-NT556”, Page 16.
- When mounting the KX-NT553/KX-NT556 with a KX-NT505 on a wall, only ONE KX-NT505 can be attached.

- 1 Insert the tabs of the wall mounting adaptor into the designated openings in the base, and then slide the wall mounting adaptor in the direction of the arrow until it clicks.

KX-NT551

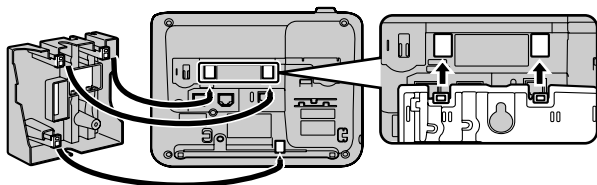

KX-NT553/KX-NT556 with KX-NT505

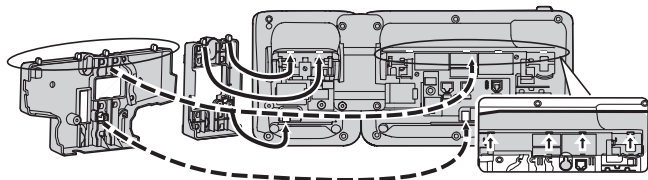

Wall Mounting

- Fasten the wall mounting adaptor(s) to the base with the screw(s). (Recommended torque: 0.4 N·m [4.08 kgf·cm] to 0.6 N·m [6.12 kgf·cm])
- Connect the cables to the unit, and run the cables through the wall mounting adaptor, as shown in the illustration below.
- Drive the screws into the wall either 83 mm or 100 mm apart, and mount the unit on the wall.

Example: KX-NT553/KX-NT556 with KX-NT505

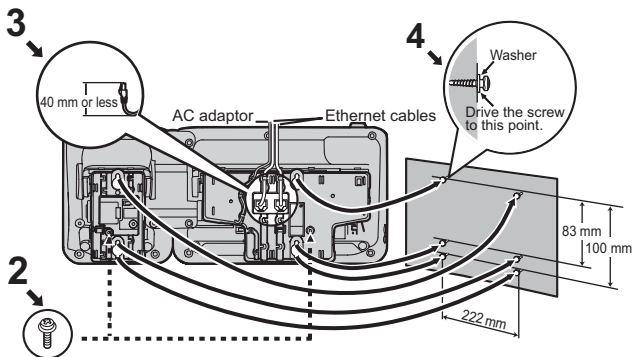

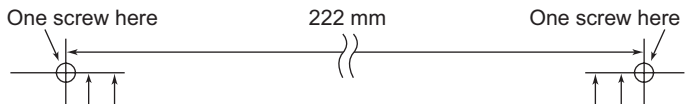

WALL MOUNTING TEMPLATE

1. Drive the screws into the wall as indicated.
2. Hook the unit onto the screw heads.

Note:

- If the KX-NT505 is mounted beside a IP-PT (KX-NT553/KX-NT556), leave 222 mm of space between the 2 screws for the IP-PT and the 2 screws for the KX-NT505, as indicated above. This space is abbreviated in this template and must be measured.

100 mm
83 mm
for IP-PT

100 mm
83 mm
for KX-NT505

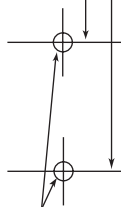

One screw at either point

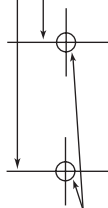

One screw at either point